

For measurements:
 Bust 100 cm
 Waist 80 cm
 Hip 92 cm

www.eTelestia.com

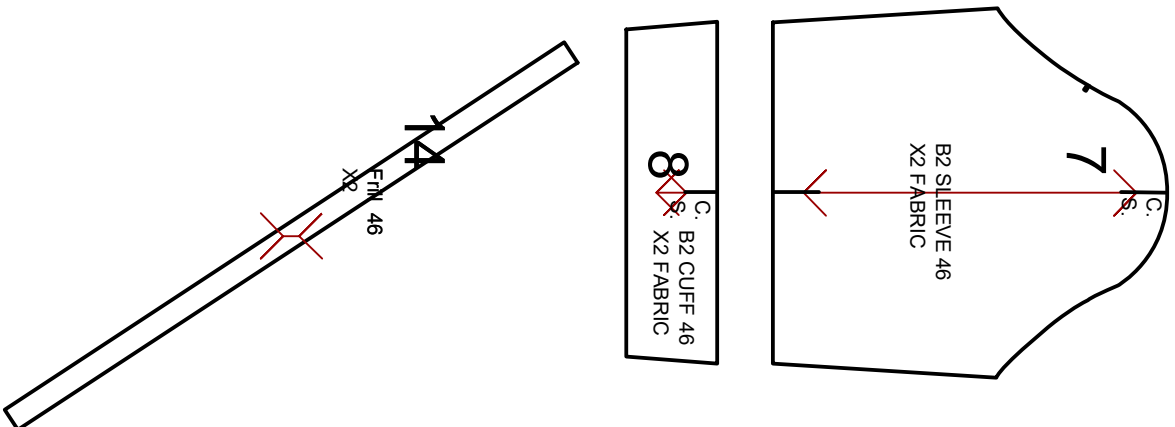

1/2 Ch.M. : 46 [Ch.B.D.	4
1/2 B.M. : 50	4
1/2 B.D. : 10	
B.L. : 26	
1/2 T.B.L. : 46	
1/4 W.M. : 19 [H.W.D.	6
1/4 H.M. : 25	6

Remember to add your seam allowance before cutting

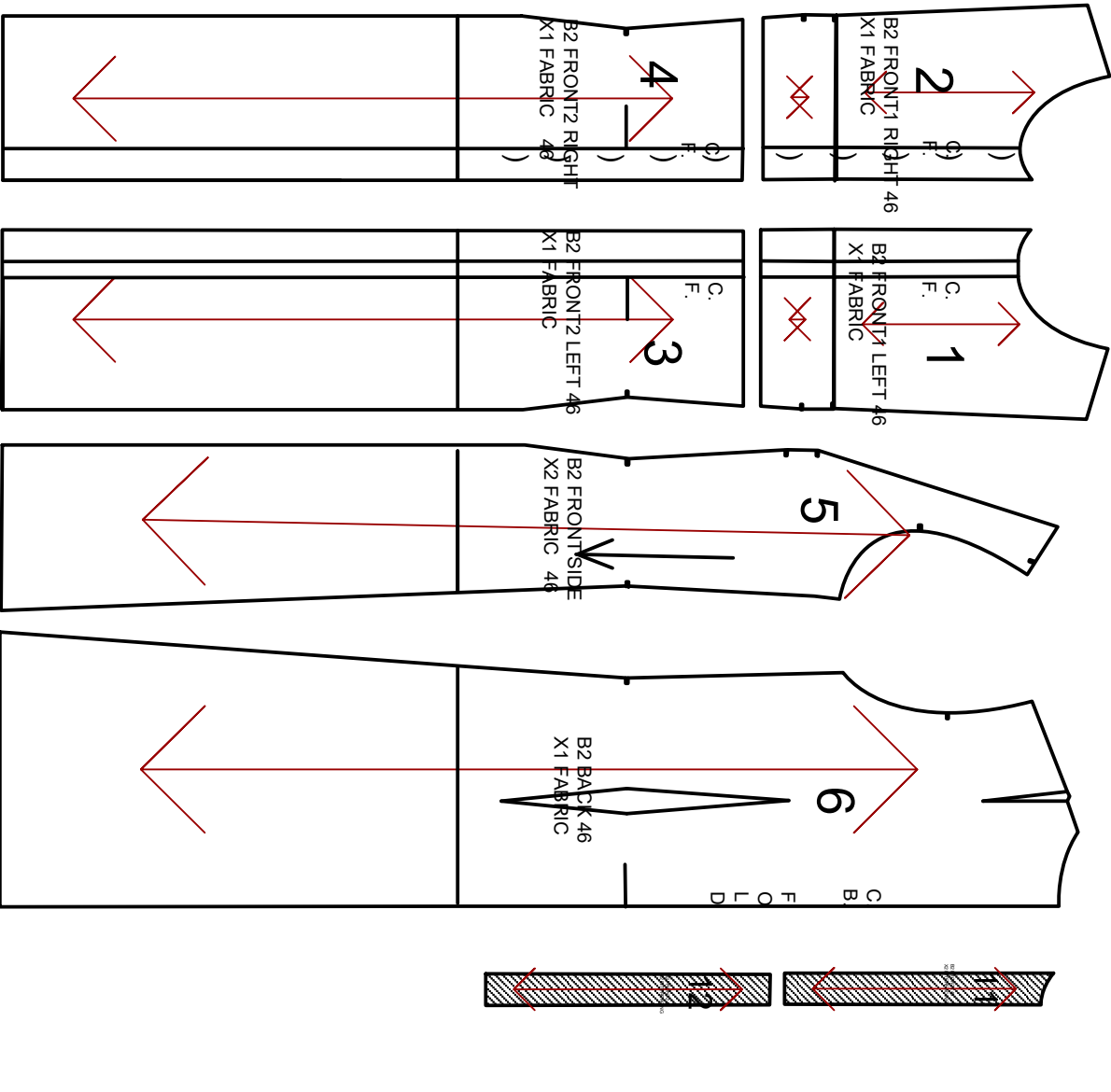

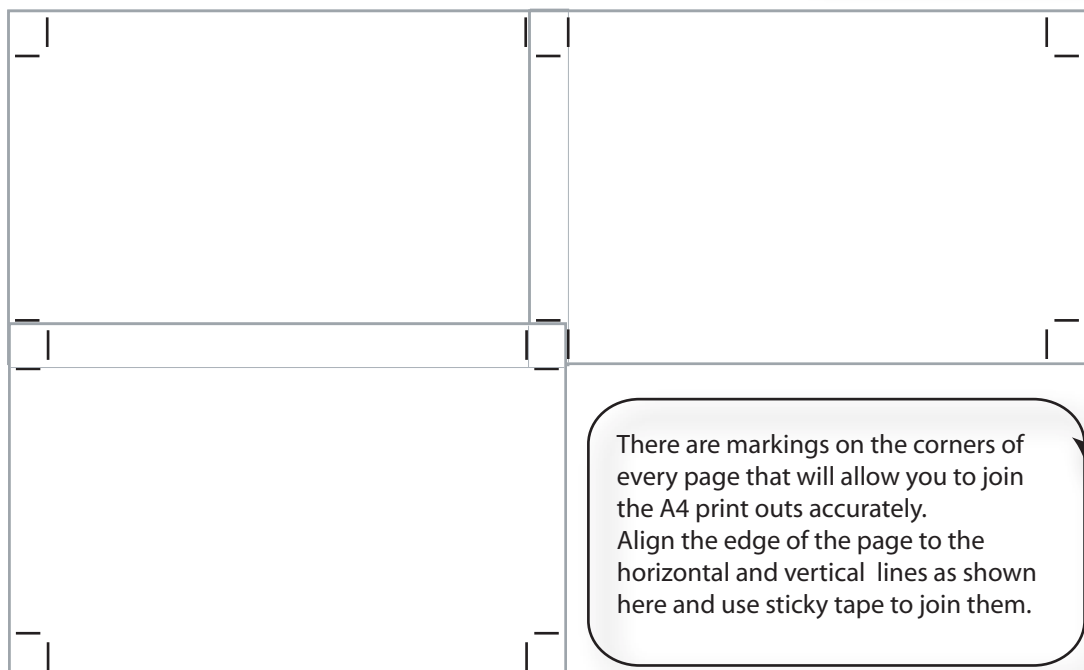
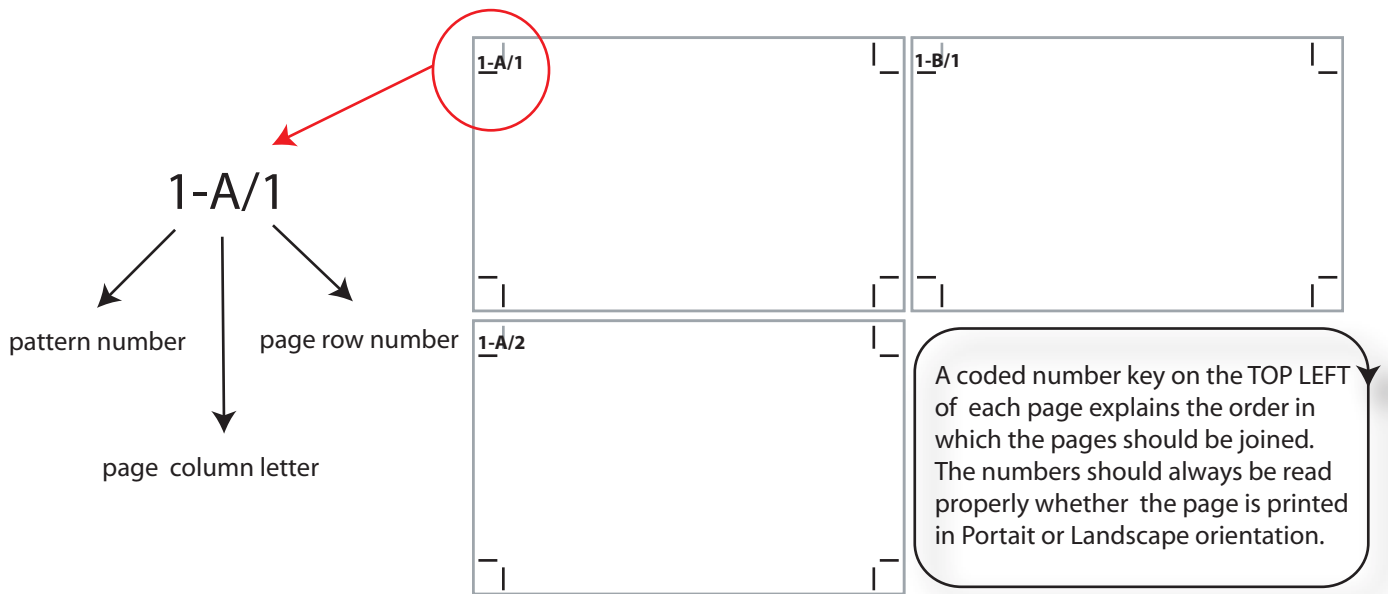
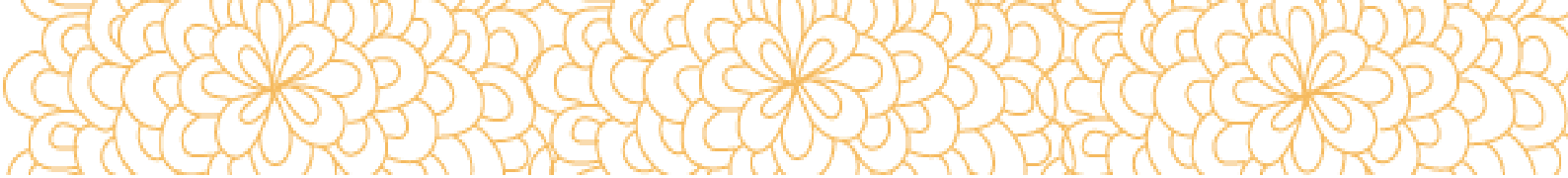

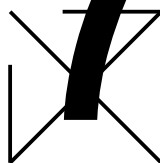
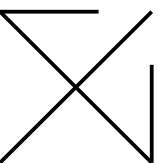
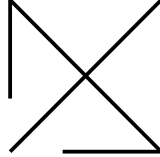
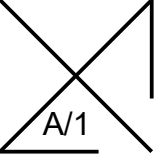

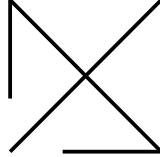
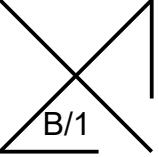

B/1

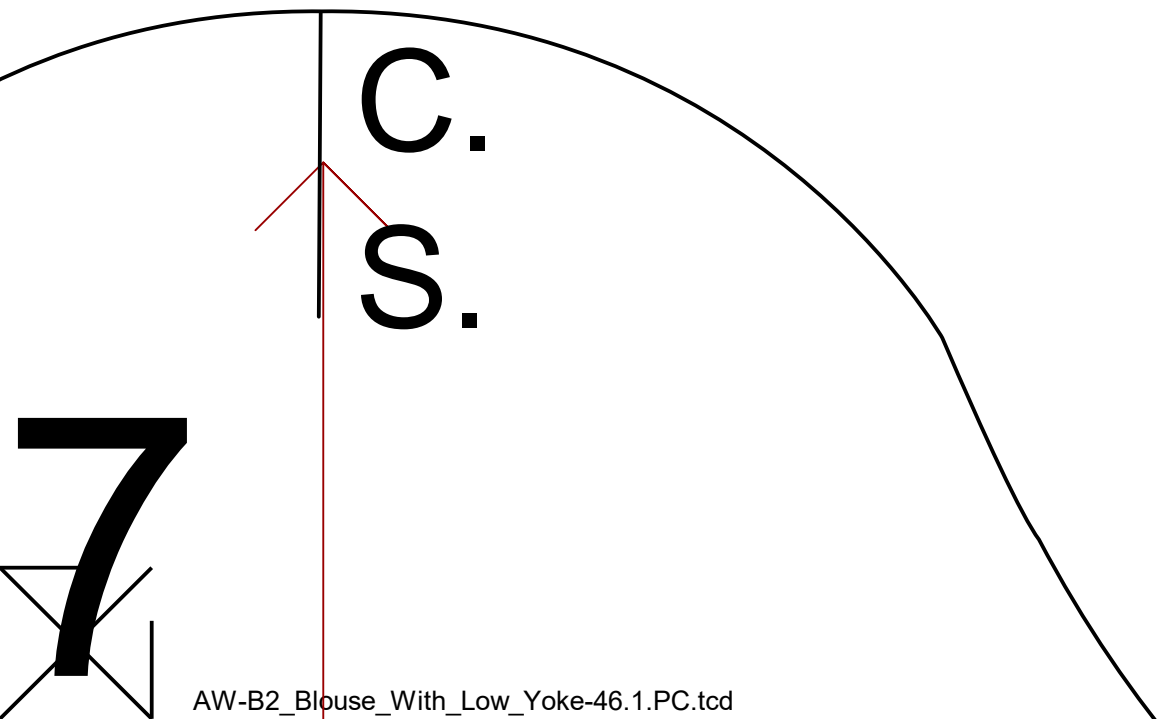

C.
S.

7

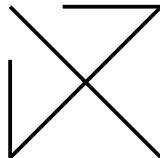

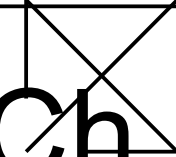
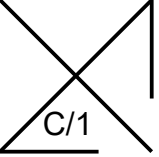

1/2 Ch.M : 46 [Ch.
1/2 B.M. : 50
1/2 B.D. : 10
B.L. : 26
1/2 T.B.L. : 46
1/4 W.M. : 19 [H.V
1/4 H.M. : 25

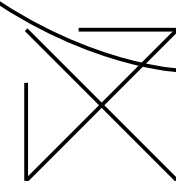
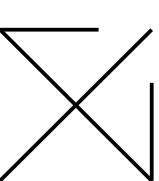
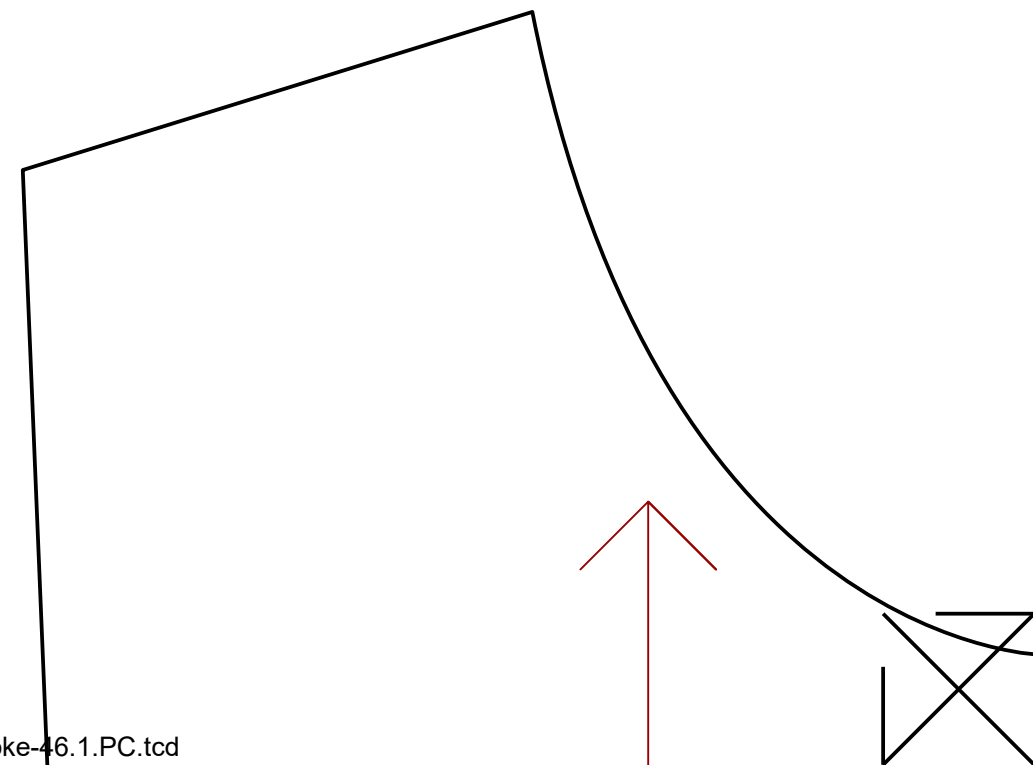

~~Ch.B.D.~~

4

H.W.D.

6

C.
B.
B.
X
FOI

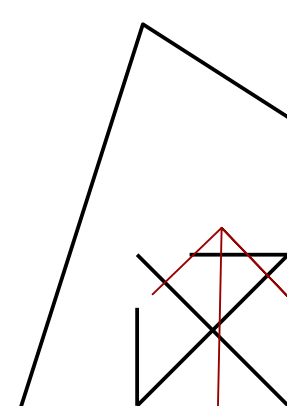
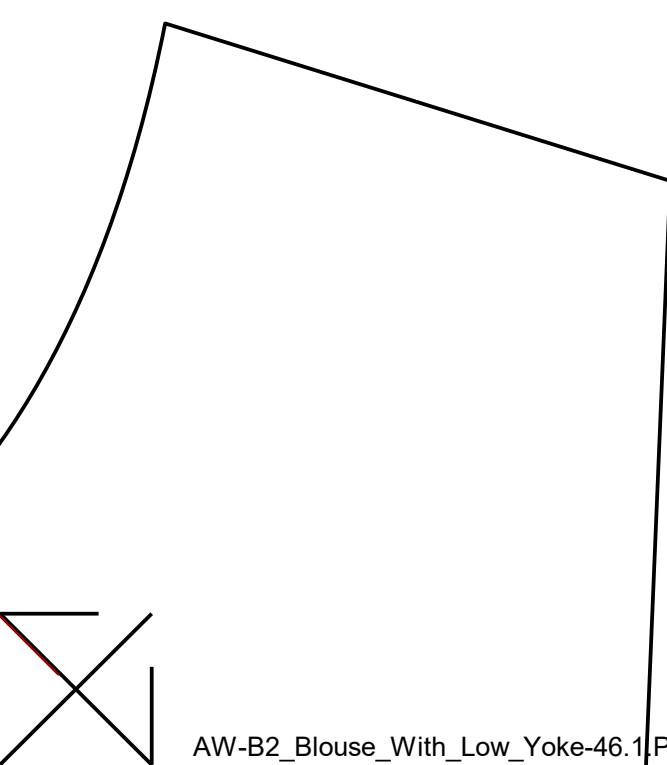
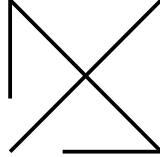
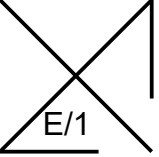

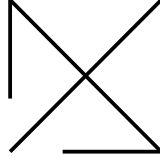
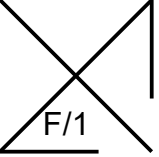



10

C. B2 LOWER COLL

B. X2 FABRIC



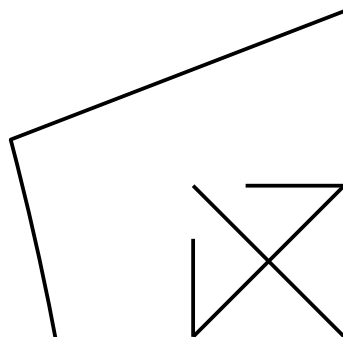
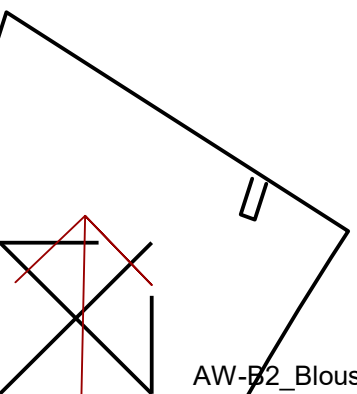

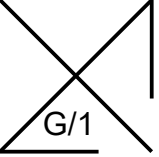

G/1

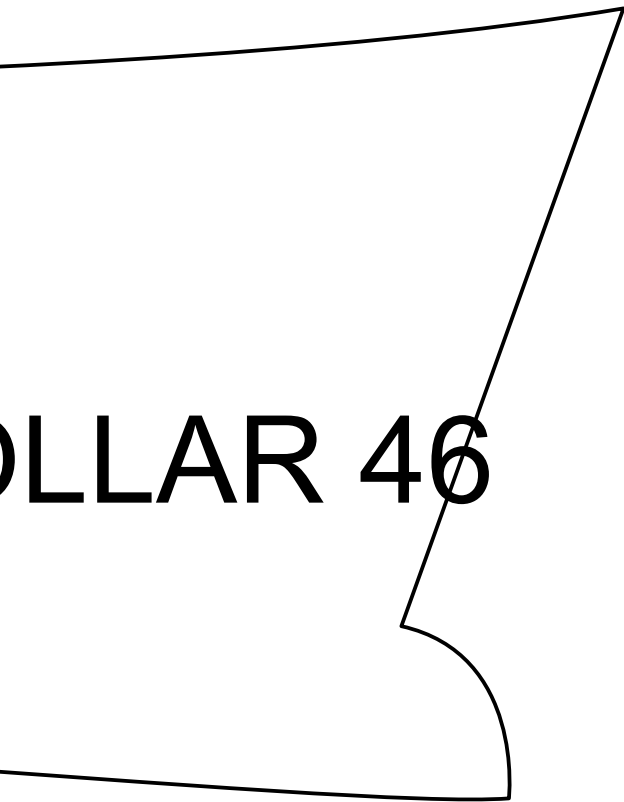
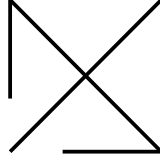

COLLAR 46

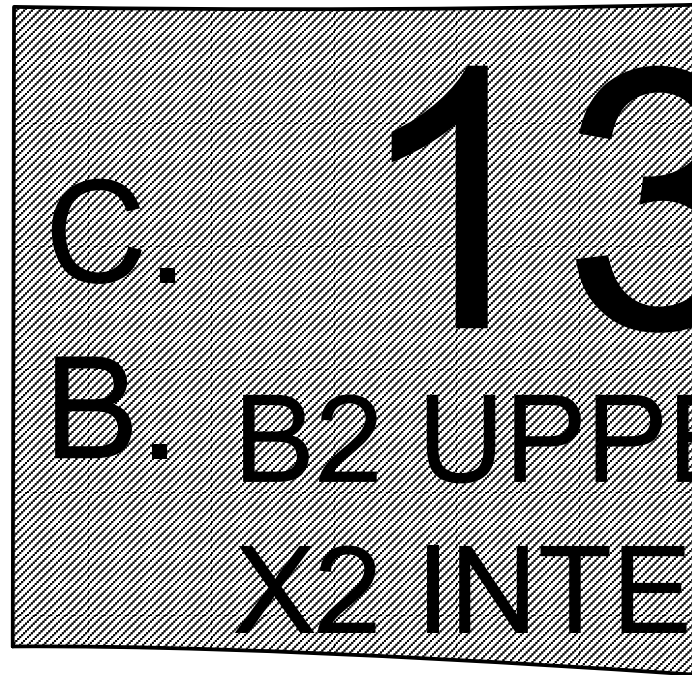

C. 13
B. B2 UPPER
X2 INTER

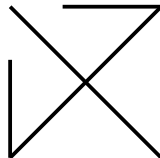
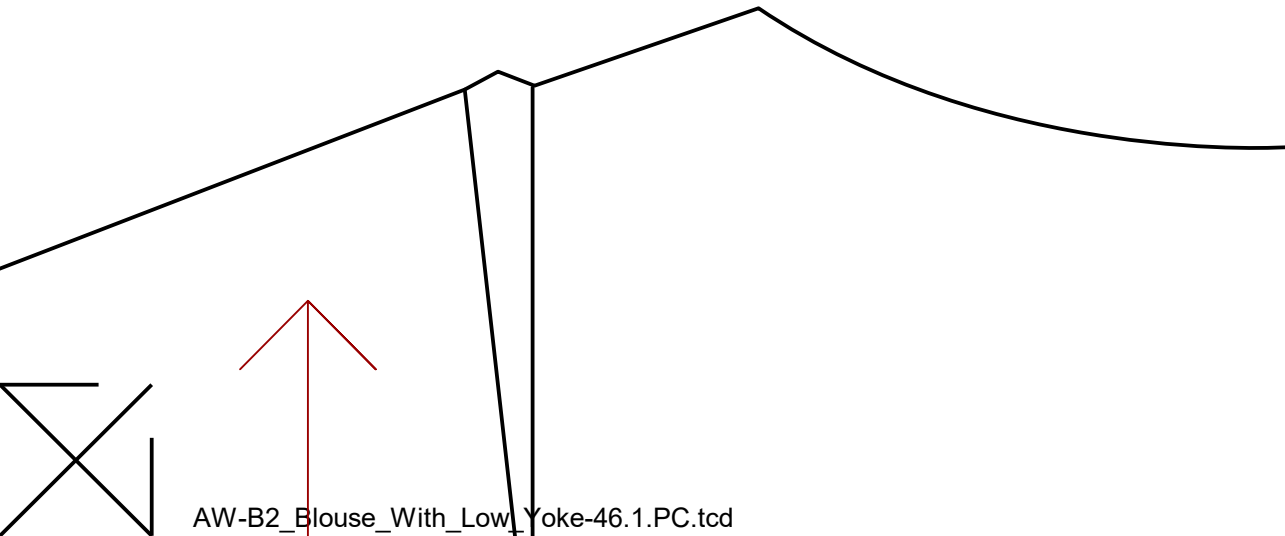

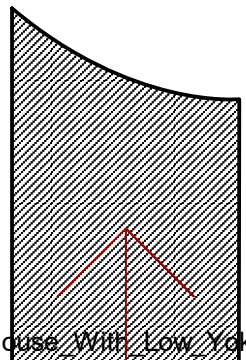
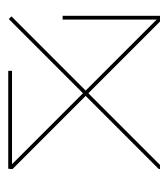
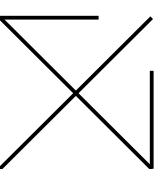
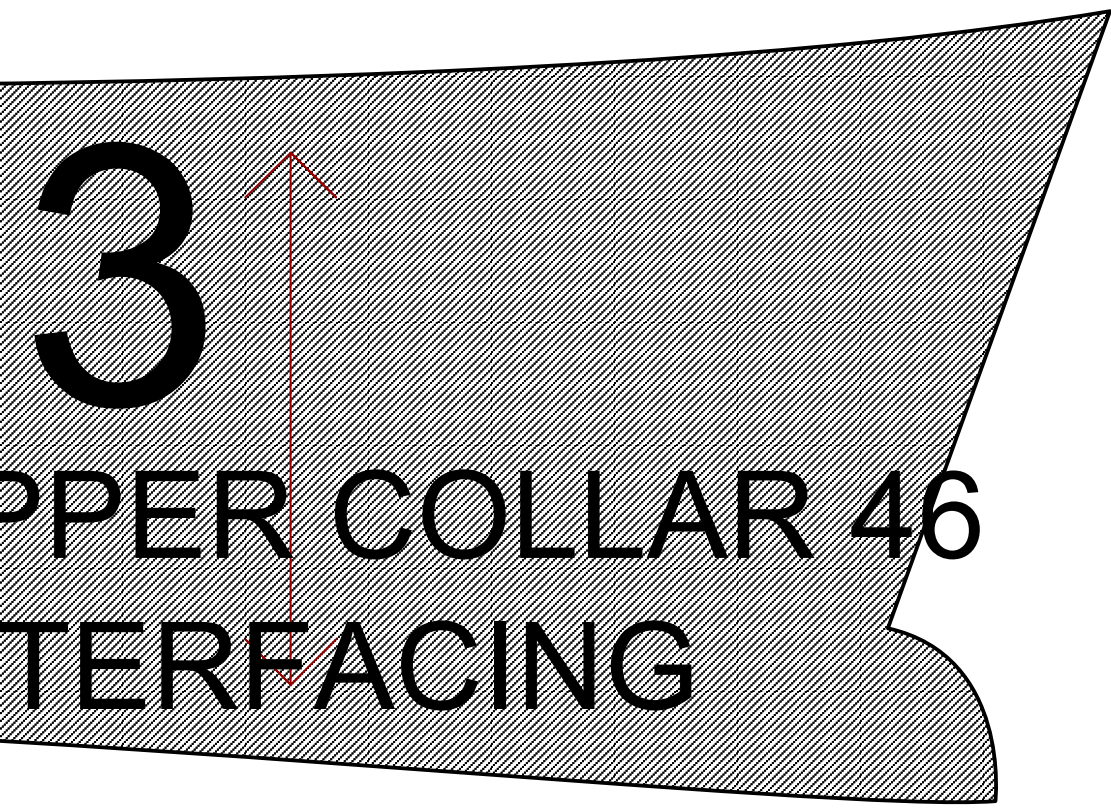
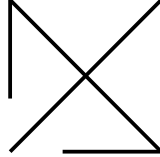
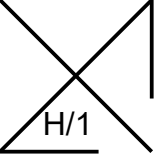

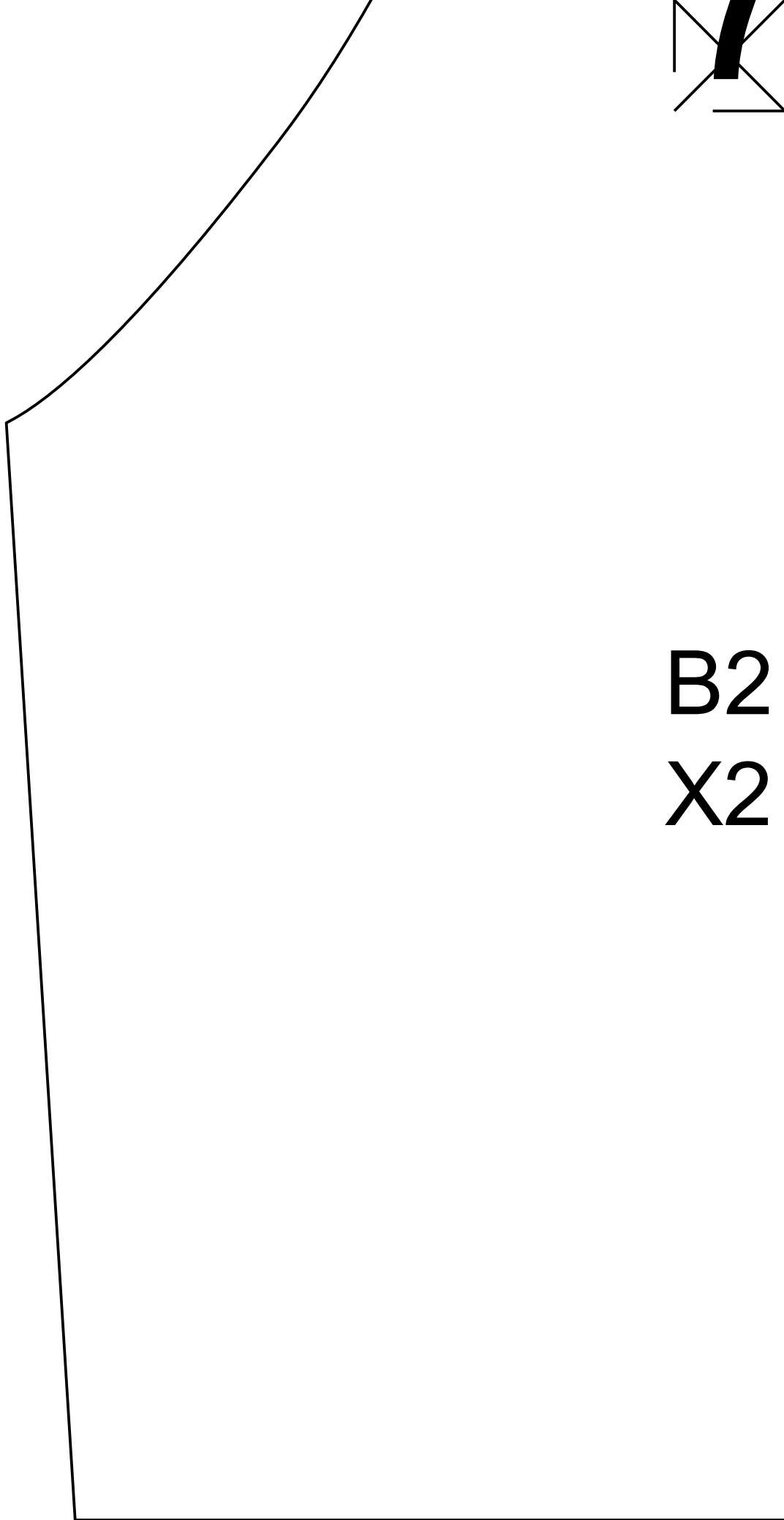
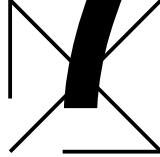
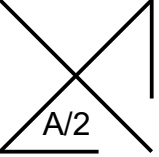

B2
X2

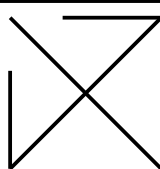
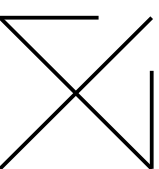



B/2

B2 SLEEVE 46

X2 FABRIC

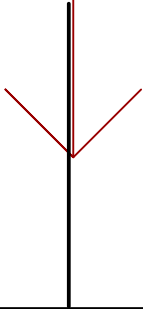

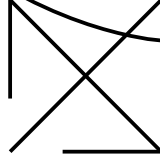
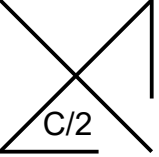

2

B2 FRONT1 RIG
X1 FABRIC

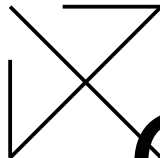

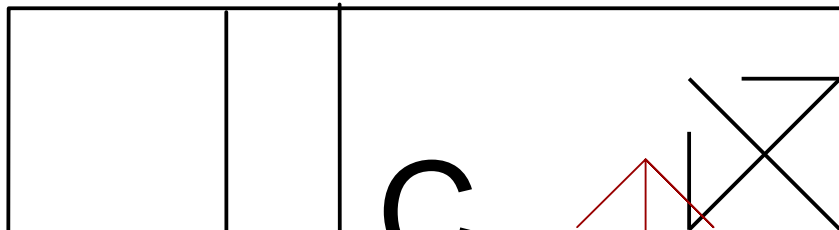
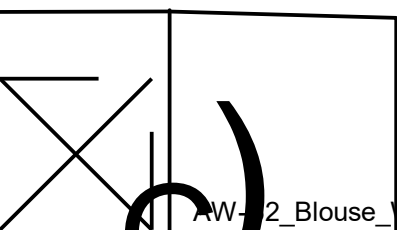
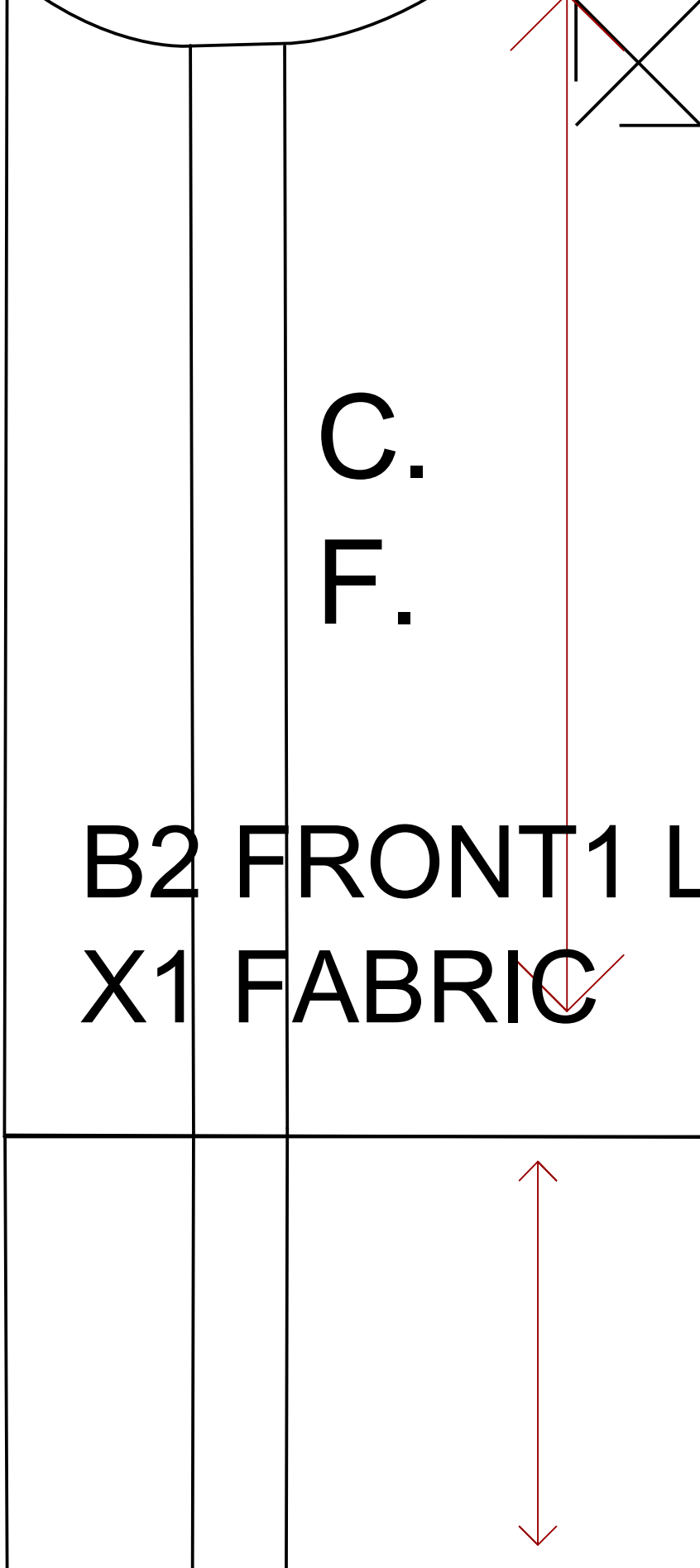

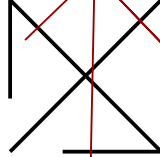
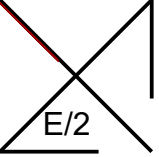

1

1 LEFT 46

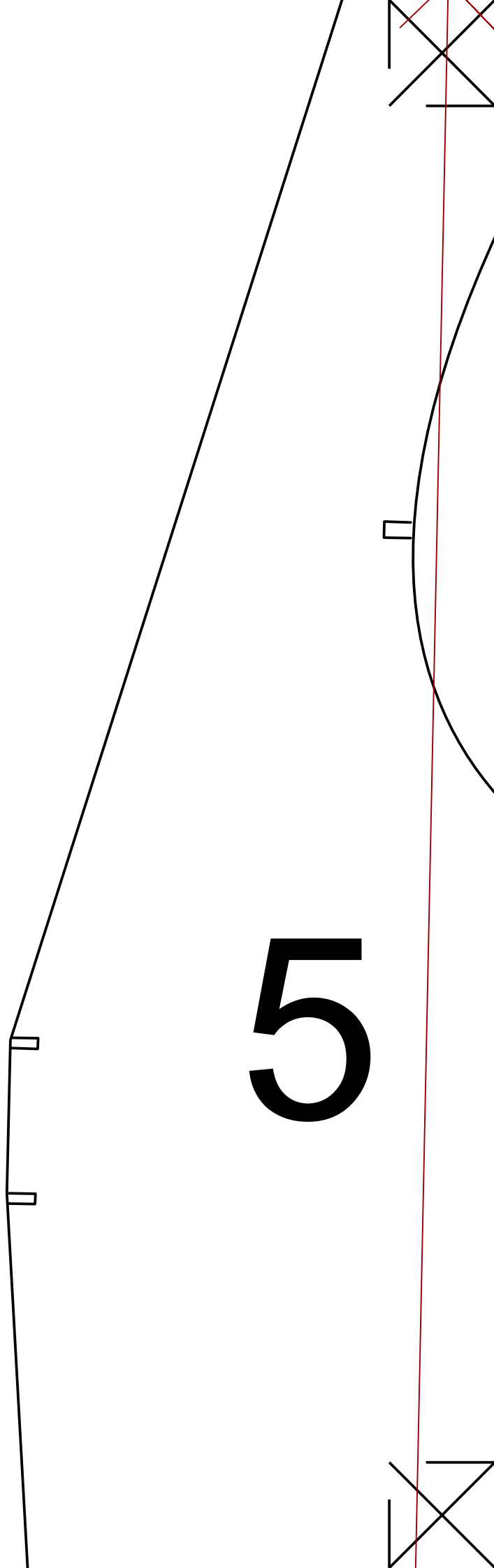
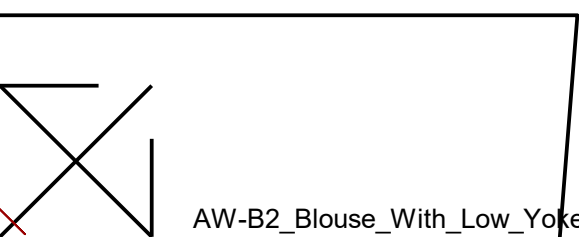
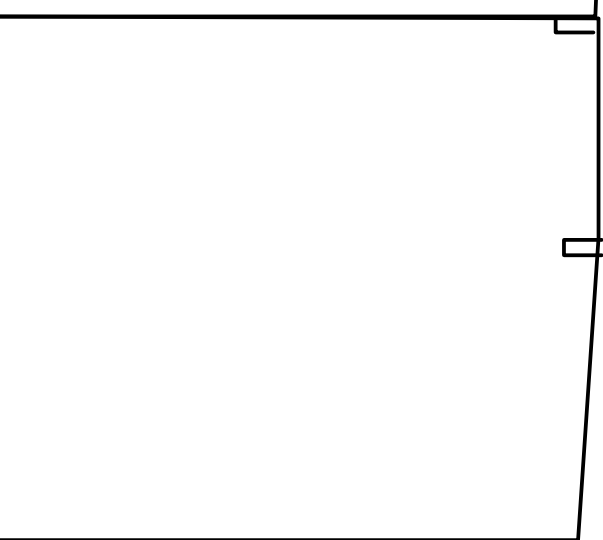

5

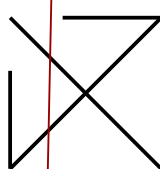

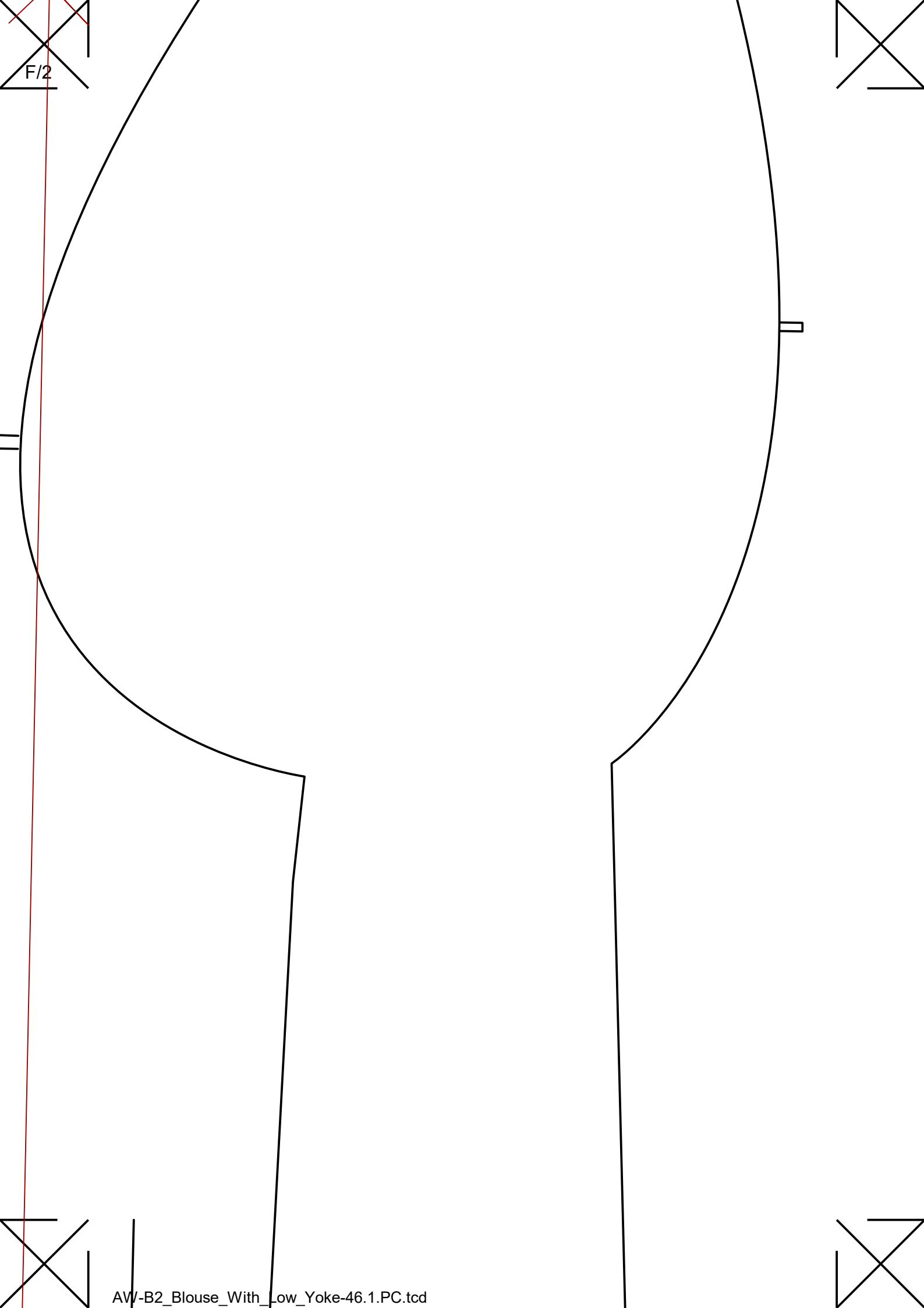

F/2

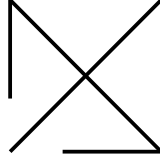
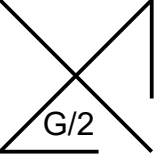

6

C.
B.
F
O
L
D

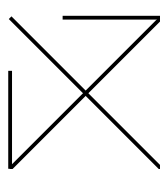
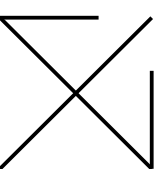

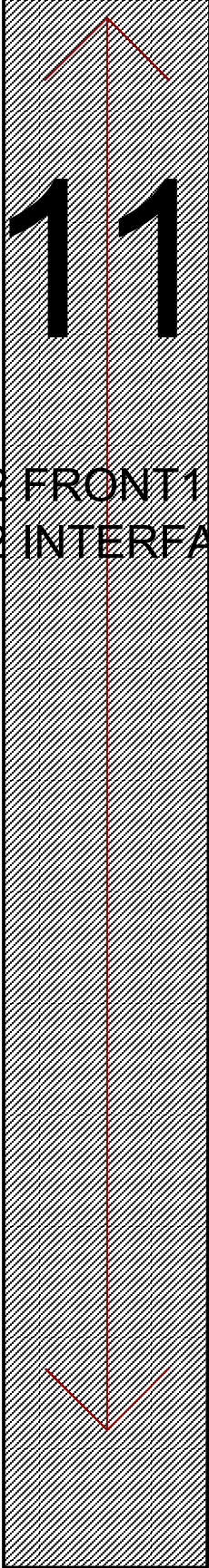
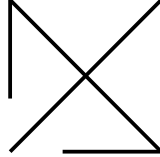
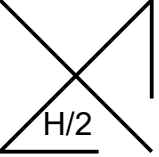

11

B2 FRONT 1.46
X2 INTERFACING

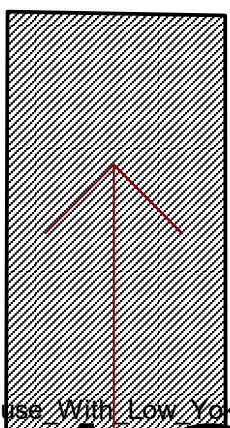
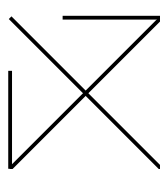
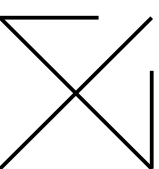

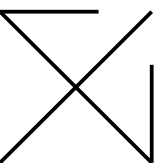
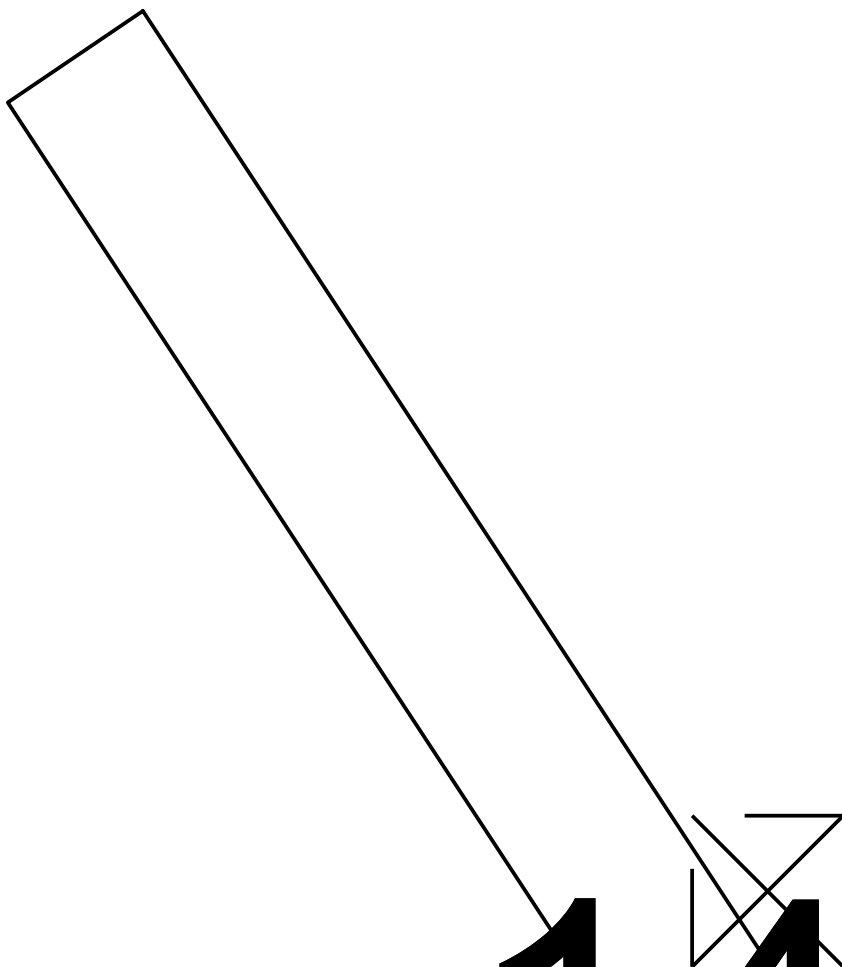
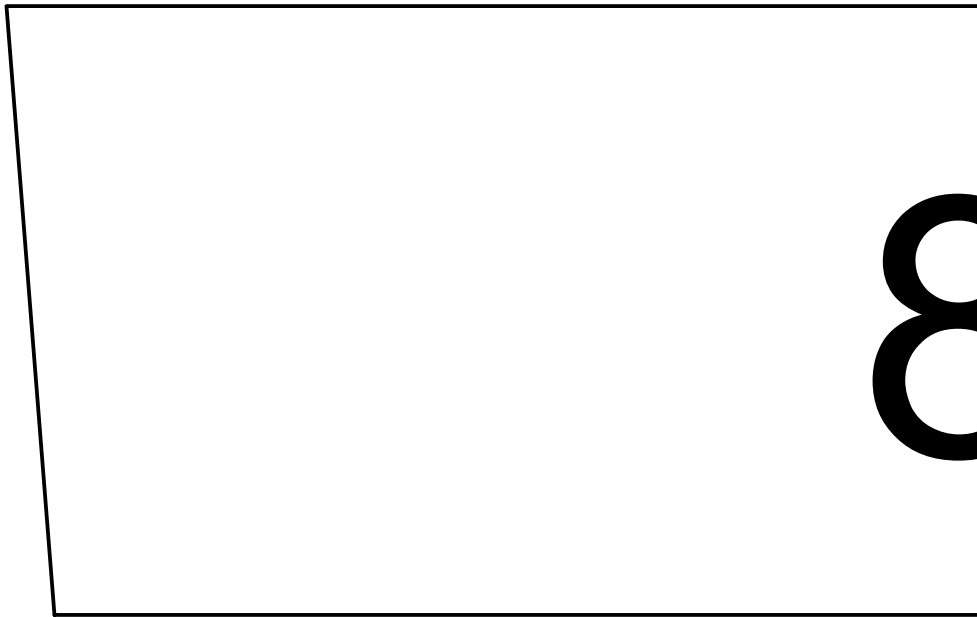
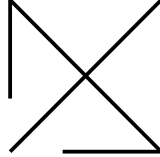
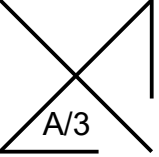

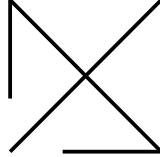
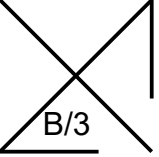

8



**C.
S.**

B2 CUFF 46

X2 FABRIC

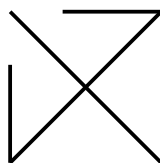

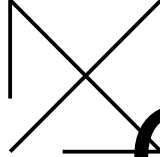
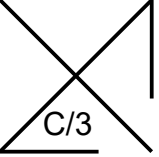

4

B2 FRONT2 RIG
X1 FABRIC 46

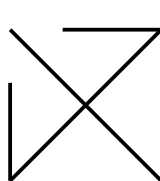
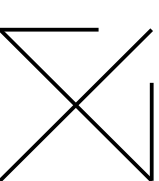



D/3

C)

F.)

)

RIGHT

46

)

)

B2 FRONT2 LE

X1 FABRIC

C.

F.

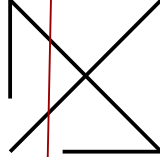
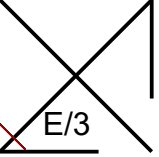

3

LEFT 46

**B2 FRONT
X2 FABRIC**

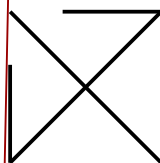
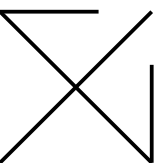



F/3

NT SIDE
IC 46

B
X

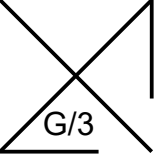

G/3

D

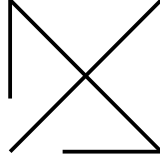

B2 BACK 46
X1 FABRIC

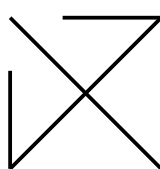
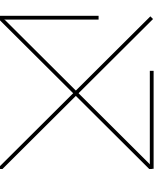
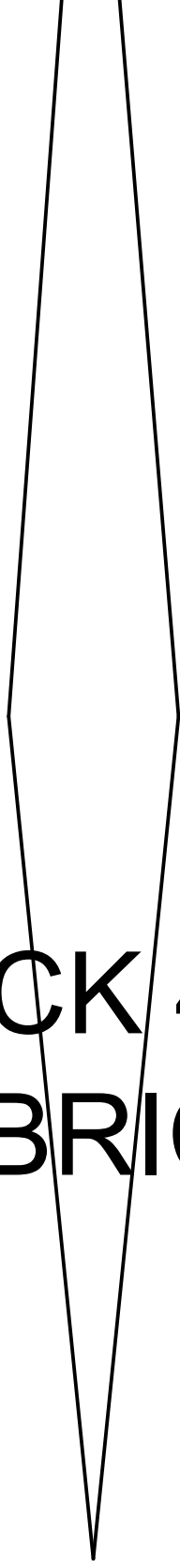

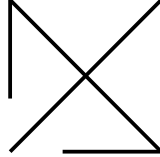
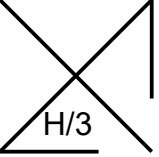

12

B2 FRONT 2 46
X2 INTERFACING

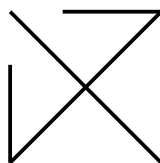
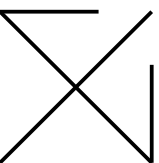
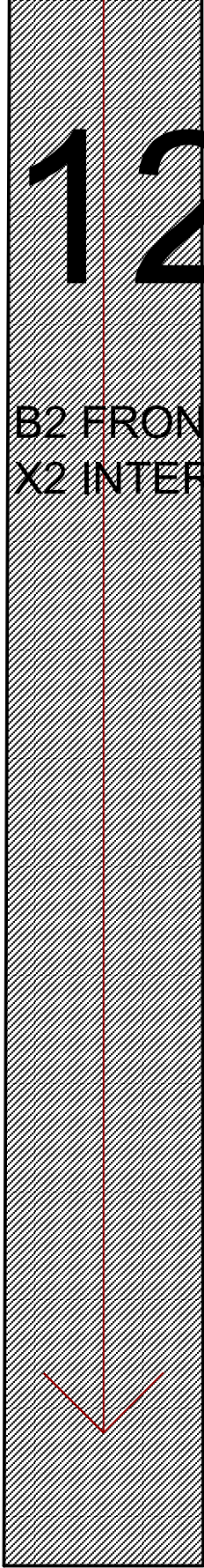

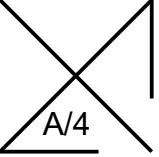

~~14~~

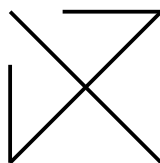
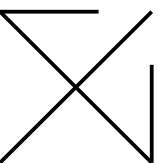

4

Frill 46

X2



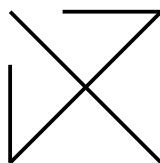
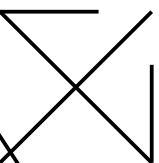
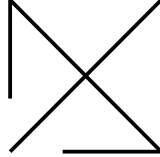
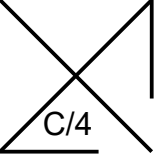

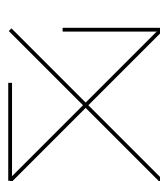
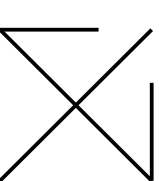
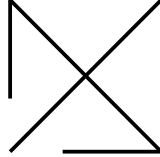
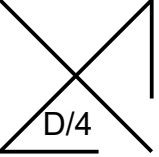

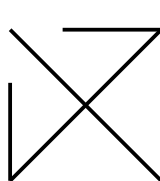
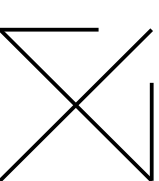
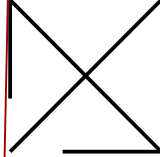
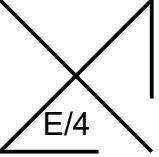

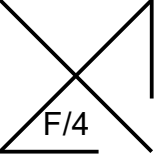

F/4

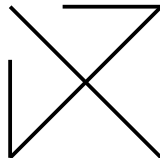
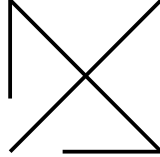

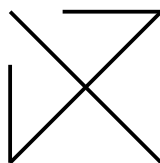
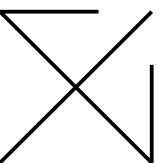
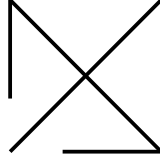
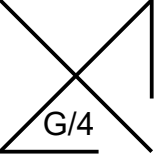

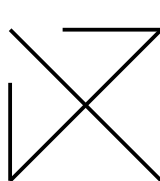
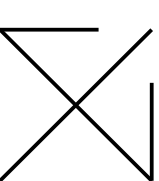
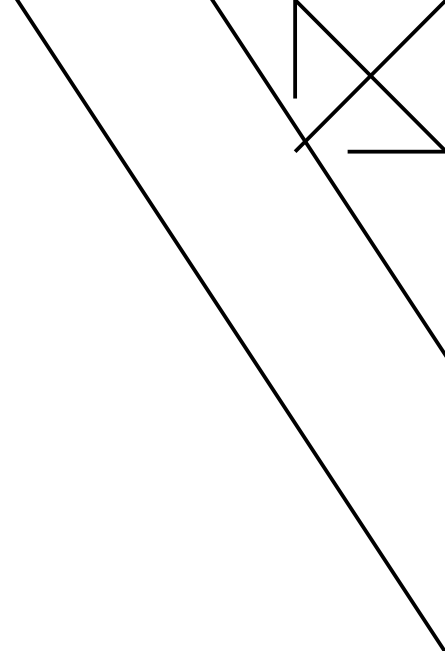
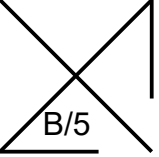

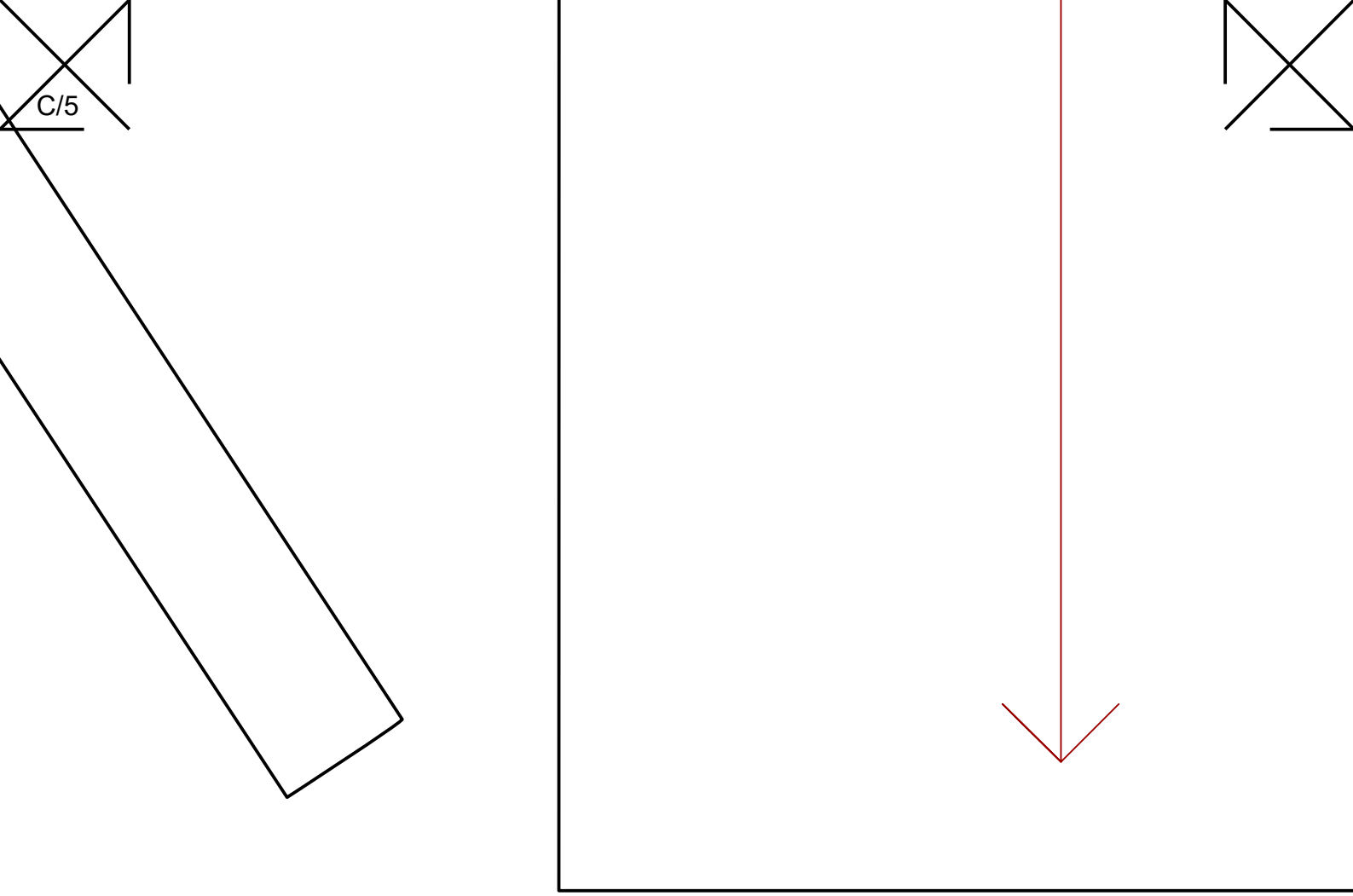

C/5

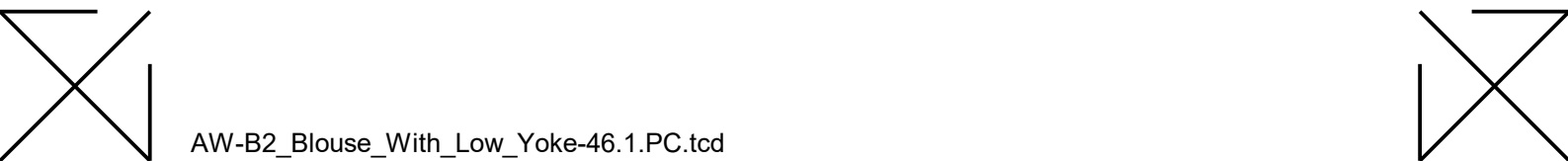
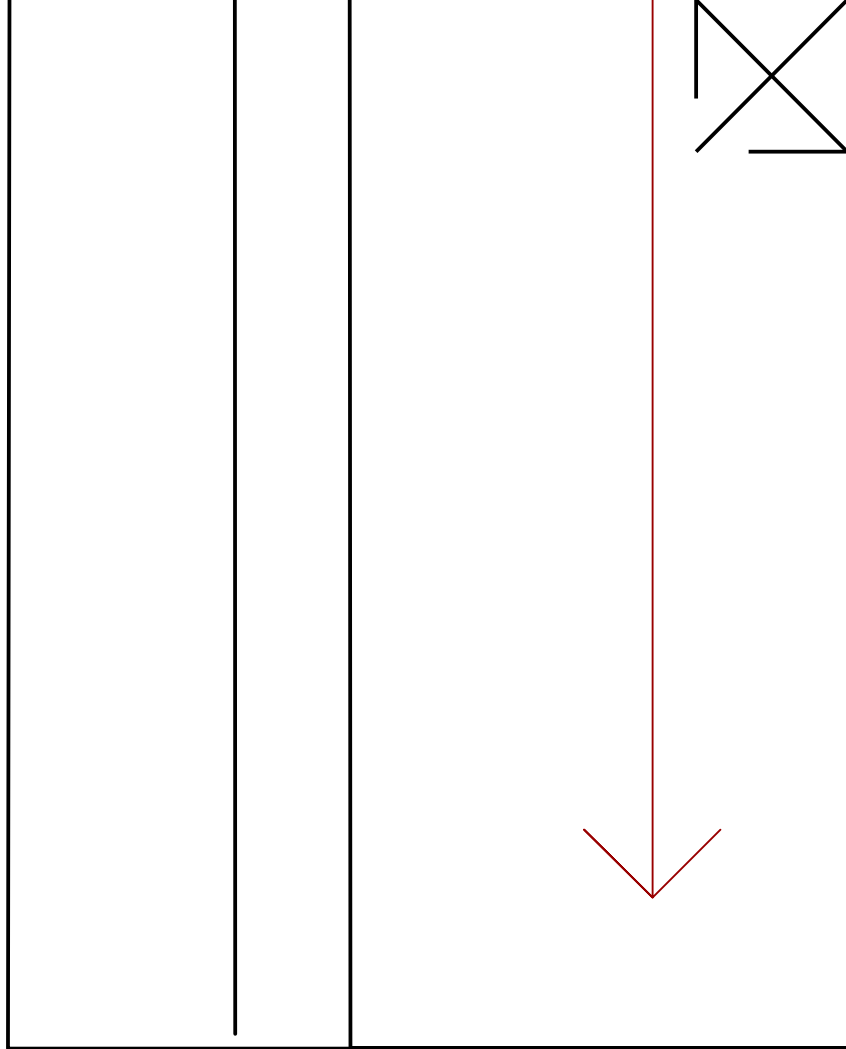
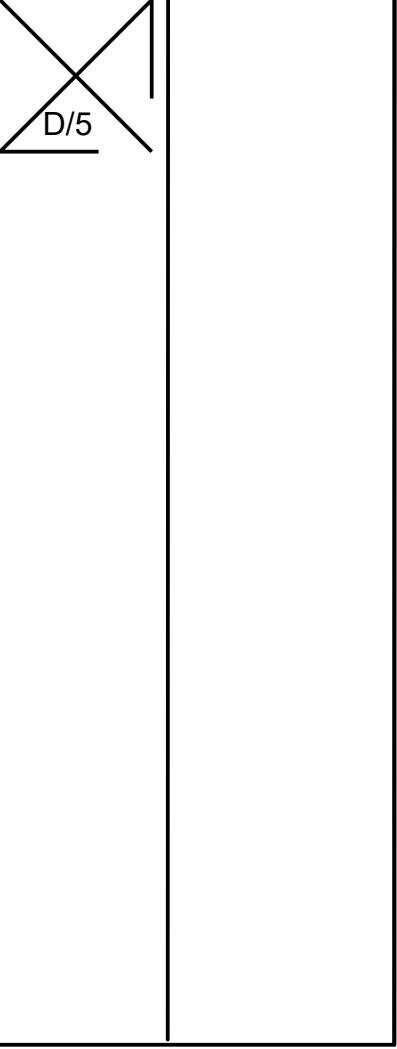

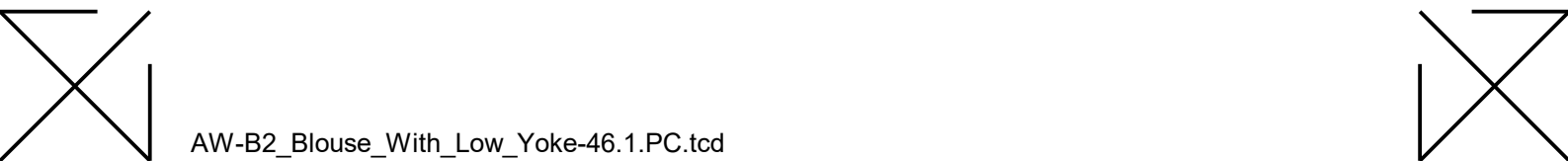
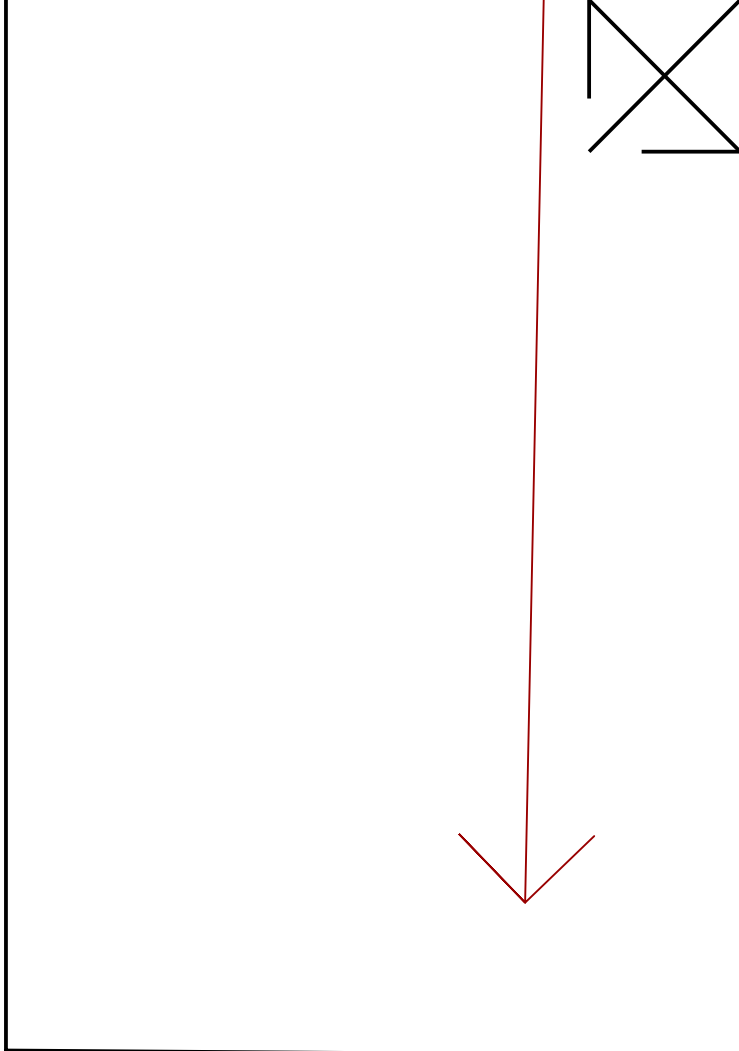

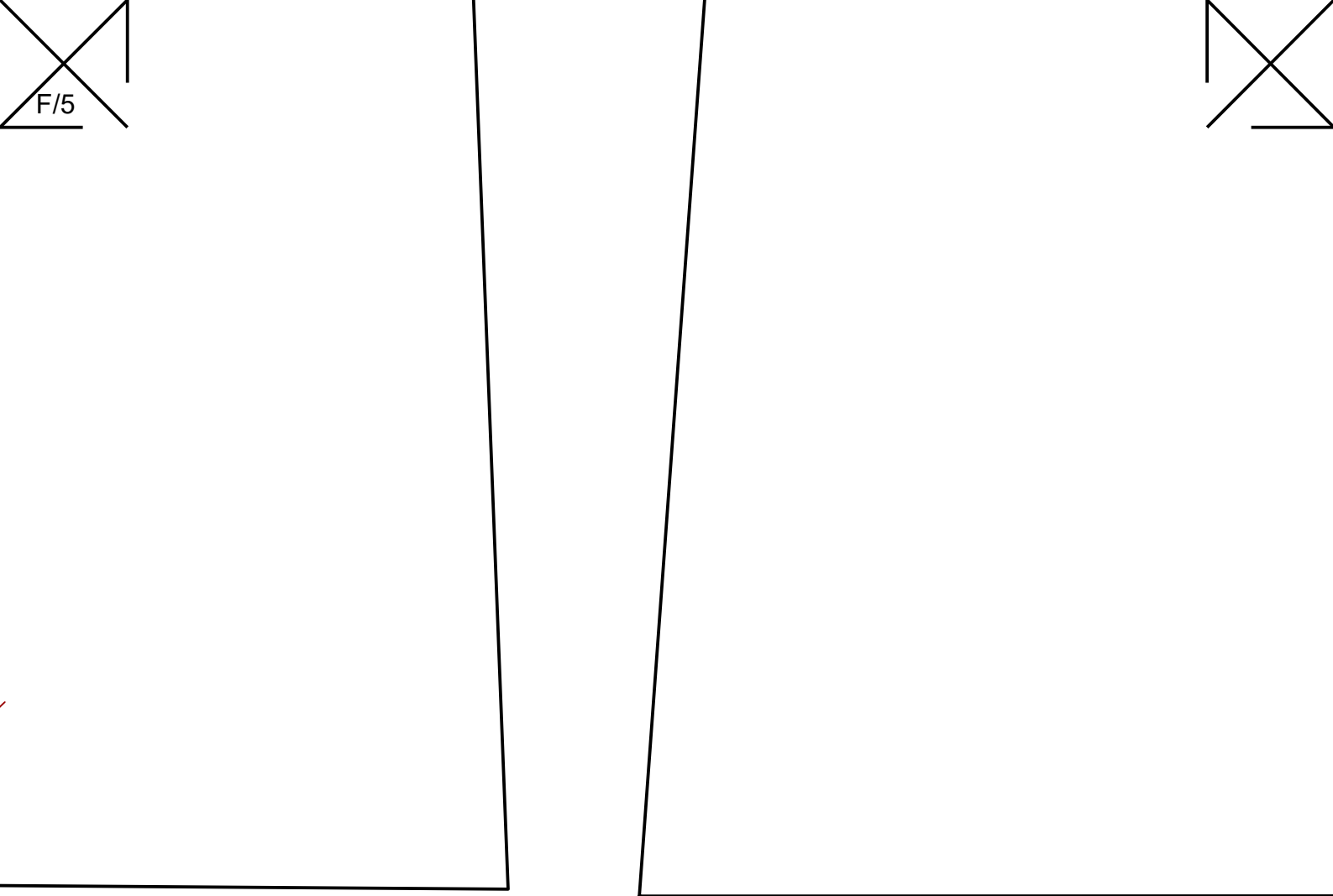

F/5

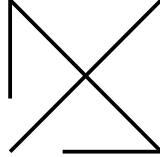
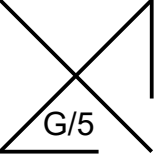

G/5

